

BS Filing Cabinets



2014-06-16

First place for workplace storage

BISLEY

BS Filing Cabinets Classic front

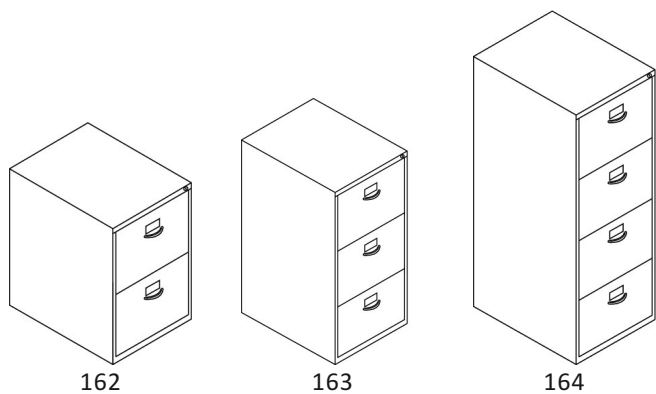

Product Code	Description	Height (mm)	Width (mm)	Depth (mm)
162	Foolscap with 2 drawers Classic Front BS2C	711	470	622
163	Foolscap with 3 drawers Classic Front	1,016	470	622
164	Foolscap with 4 drawers Classic Front	1,321	470	622
362	A4 with 2 drawers Classic Front	711	413	622
363	A4 with 3 drawers Classic Front	1,016	413	622
364	A4 with 4 drawers Classic Front	1,321	413	622



BS Filing Cabinets Flush front

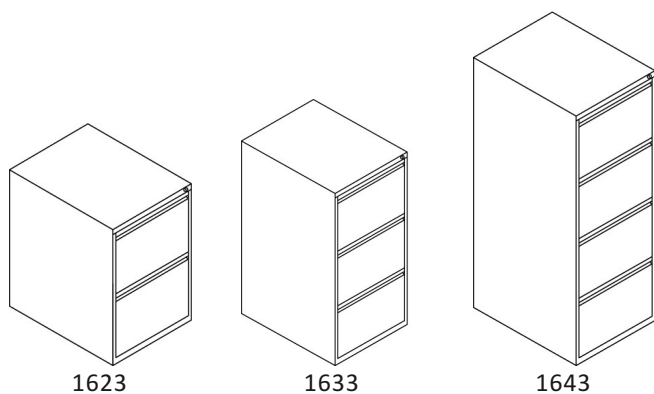

Product Code	Description	Height (mm)	Width (mm)	Depth (mm)
1623	Foolscap with 2 drawers Flush Front BS2E	711	470	622
1633	Foolscap with 3 drawers Flush Front	1,016	470	622
1643	Foolscap with 4 drawers Flush Front	1,321	470	622
3623	A4 with 2 drawers Flush Front	711	413	622
3633	A4 with 3 drawers Flush Front	1,016	413	622
3643	A4 with 4 drawers Flush Front	1,321	413	622















Filing Cabinet Accessories

Product Code	Description	Height (mm)	Width (mm)	Depth (mm)
BSCPAHSP5	BS A4 Compressor plates pack of 5	260	307	
BSCPF5DP5	BS Foolsap 5 Drawer Compressor plates pack of 5	240	364	
PCF744FP4	BS Foolsap 2,3 & 4 Drawer Compressor plates pack of 4	260	364	
PCF744FP5	BS Foolsap 2,3 & 4 Drawer Compressor plates pack of 5	260	364	
PFBBSPSFP1	File bars to convert Foolsap drawers for A4 filing (single pack)			
PFBBSPSFP10	File bars to convert Foolsap drawers for A4 filing (pack of 10)			

2014-06-16

Technical data sheet

standard / trade colour palette

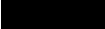
	Orange (15%*)
	New Blue (15%*)
	Silver (10%*)
	Light Grey
	Goose Grey
	Graphite (10%*)
	Edinburgh
	Chalk (15%*)
	Beige
	Cream
	Coffee
	Yellow (15%*)
	Green (15%*)
	Pink (15%*)
	Oxford Blue (10%*)
	Black

* surcharge

Colour blocks are only approximations, please refer to Bisley metal colour samples for an exact representation.

BS Filing Cabinets



1. Label holder



2. BS lock and key



3. Filing drawer suitable for suspension filing

The BS cabinet is strong and quiet. Its fully-welded carcass makes it suitably robust, while roller bearing slides ensure ultimate ease of use; a 'positive closing device' allows the drawer to close with precision, from the lightest of touches. It comes in two, three, four and five-drawer versions and a choice of fronts – classic (with neat polished handle) or flush (with finger-pull action) in either A4 or Foolscap dimensions.

- Designed for suspension filing
- Fully welded carcass without bolts or rivets for greater strength and cleaner line
- Backs and sides are pierced to enable units to be bolted together
- Mastered lock with 200 differs

Technical Information

Guarantee (years):	7
Slide type:	80-900-069L/R 100% extension drawers (0.56m linear capacity)
Key information:	92 series, 200 differs, 92201-92400, mastered Std - P800817 Same Number - P800864
Quality accreditation:	BS EN 14073 2004 Part 2 & 3, BS EN 14074, BS 4875 1998 Part 7 level 4 & Part 8, BS 5459 1983 Part 3, DIN 4554/485, ANSI/BIFMA X5.2, 5.3 & 5.5, 1997/98, level 5.3 NB: Drawers tested to BS4875, Part 7, Table 3 Test Level 4, 80,000 cycles

Contact details

Bisley Head Office & Sales

Telephone: +44 (0) 1483 485600
Fax: +44 (0) 1483 489962
www.bisley.co.uk
info@bisley.com

Bisley Design & Production

Telephone: +44 (0)1633 637 383
Fax: +44 (0)1633 637 384
www.bisley.co.uk
info@bisley.com

Bisley Showroom

Telephone: +44 (0)20 7436 7111
Fax: +44 (0)20 7436 8111
www.bisley.co.uk
info@bisley.com

Bisley Mobile Shelving

Telephone: +44 (0) 1483 485600
Fax: +44 (0) 1483 489962
www.bisleymobileshelving.com
mobileshelving@bisley.com

Bisley BV

Telephone: + 31 (0)13 463 0662
Fax: + 31 (0)13 463 9615
www.bisley.nl
info@bisley.nl

Bisley España, S.L

Telephone: +34 94 633 32 00
Fax: +34 94 633 32 33
www.bisley.es
info@bisley.es

Bisley France

Telephone: +33 (0)1 41 39 97 20
Fax: +33 (0)1 41 39 97 21
www.bisley.fr
info@bisley.fr

Bisley Office Furniture Ireland Ltd

Telephone: 00353 1 2769100
Fax: 00353 1 2769101
www.bisley.ie
info@bisley.ie

Bisley GmbH Hauptsitz und Showroom

Telephone: +49 (0)211 87541 600
Fax: +49 (0)211 87541 899
www.bisley.de
info@bisley.de

Bisley GmbH Stuttgart Showroom

Telephone: +49 (0)211 87541 701
Fax: +49 (0)211 87541 899
www.bisley.de
info@bisley.de

Bisley Dubai

Telephone: +971 4 4503747
Fax: +971 4 4508926
www.bisleyjlt.com
Jhoanna.Rivera@bisley.com,
Glenys.King@bisley.com

Bisley North America

Telephone: +1 212 675 3055
Fax: +1 206 971 5088
www.bisleyus.com



BISLEY

URS CERTIFICATE NO.11599/1

URS CERTIFICATE NO.11599A/1